

## Spherical Roller Bearings

## NBI bearings history milestones

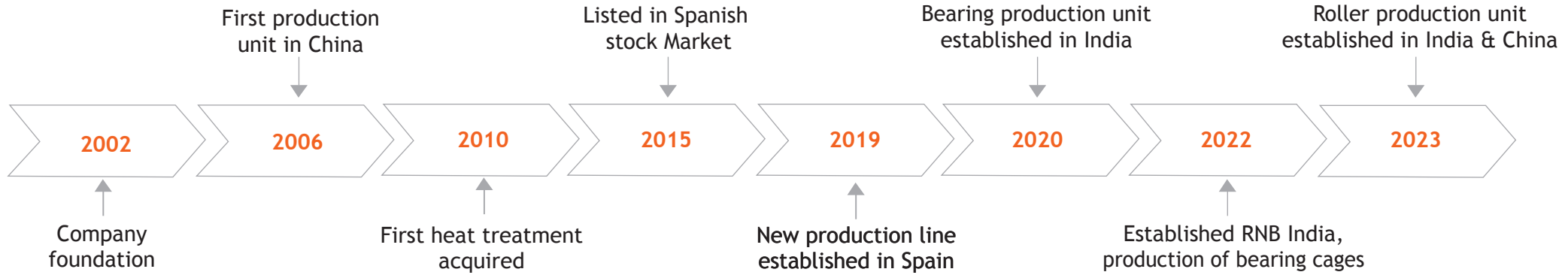
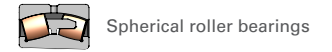

## Global footprint of the bearings division

### NBI BEARINGS EUROPE

NBI headquarter, R&D, designing, manufacturing plant, warehouse and sales office in Oquendo (Spain)

### NBI BEARINGS ROMANIA

Application engineering and sales office in Bucharest (Romania)

### LOCAL SALES SUPPORT

in Brasil, Mexico, Chile, Peru, USA

### NBI INDIA

Manufacturing plant and warehouse in Ahmedabad and sales office in Kolkata (India)

### RNB COMPONENTS

Manufacturing plant of bearings steel cages and other auxiliary components in Rajkot (India)

### CRONOS

Manufacturing plant warehouse and sales office in Wujin (China)

### WAFANDIANG SQA

Laboratories in Wafandiang (China)

### JERRY BEARINGS TRANSMISSION TECHNOLOGY

Roller manufacturing plant in Zhejiang (China)

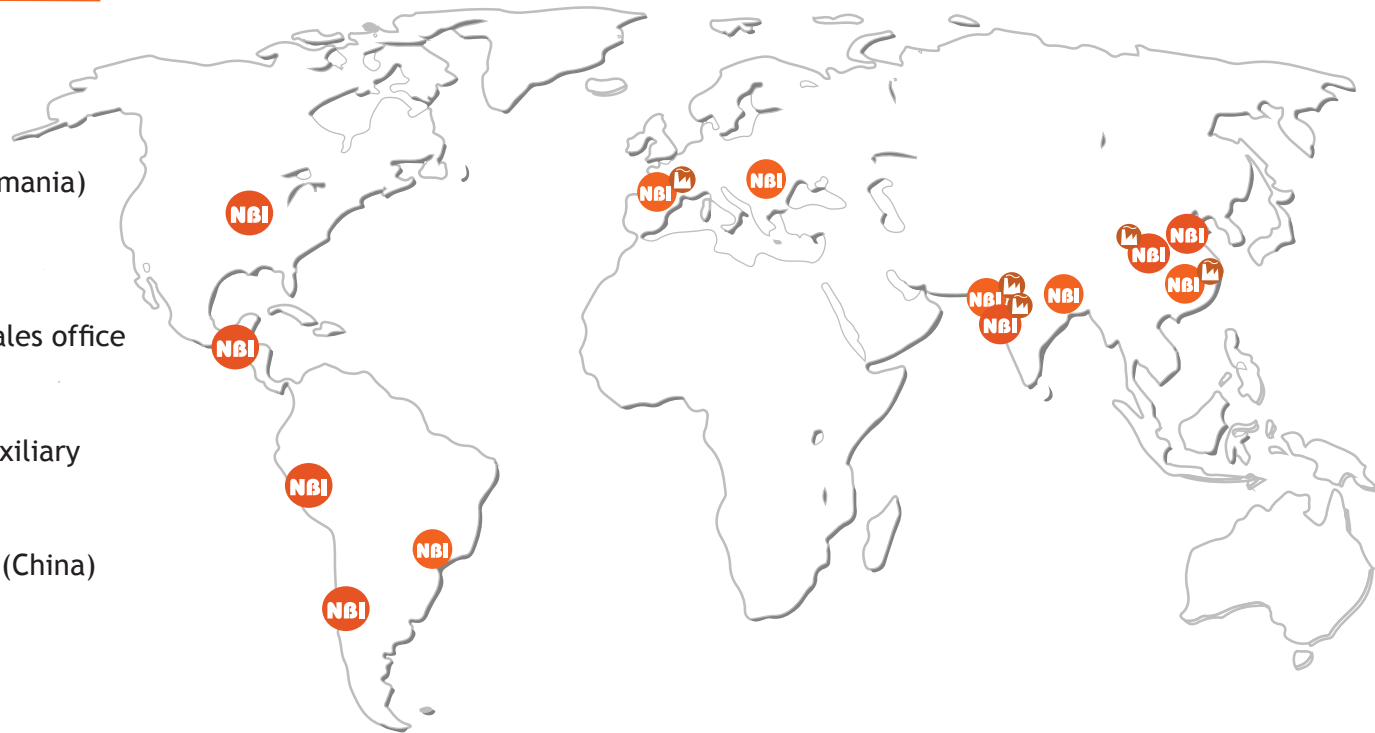

## Strengths



### Commercial capacity

Supplying bearings for a variety of OEM's applications with high technical requirements

Very active **commercial team** distributed across Spain, India, USA, Romania and Brazil

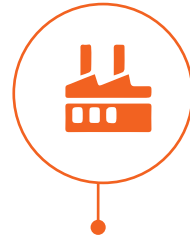

### Design and manufacturing

Continuous investment in **R&D** supported by own design softwares and life test simulation programs

**Manufacturing plants** in Spain, China and India for CRB, SRB, TRB, CRTB, SPB and CF



### Financial Position

**Solid financial health** thanks to a robust cash position

**Publicly listed** in the BME Growth (Spanish stock exchange) since 2015 with stable core shareholders



### Strategic alliances

NBI maintains a **strategic partnership** with Cronos (bearing manufacturer) with 30% equity stake

**Joint Ventures** to integrate vertically the production of bearing components

## Application engineering



### Bearing performance optimization



### Bearing damage analysis



### Advanced calculation capabilities



### Assistance for maintenance issues, fitting practice, internal clearance selections



### Lubrication analysis



### Technical trainings and seminars

# NBI Spherical Roller Bearing (SRB)

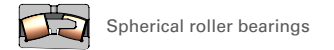

All NBI spherical roller bearing products have in common several features that contribute to an enhanced performance:

- Internal geometry optimized for high load carrying capacity
- Symmetrical rollers
- Osculation ratios optimized for achieving lower stress levels, lower torque, good roller stability and traction forces
- High steel purity and optimized microstructure by isothermal hardening
- Reduced raceway roughness and improved textures
- Dimensional stabilization for high temperatures



## Models of cages

Six different models with different characteristics according to material and construction style, depending on the application where the bearing is intended to be used. Overall, NBI's spherical roller bearings are designed to provide performance in today's increasingly demanding industrial environment.

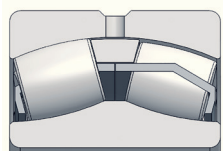

E design

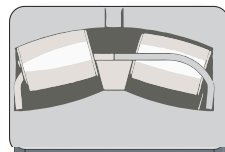

CC design

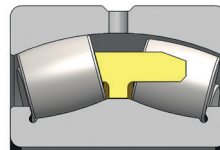

CA design

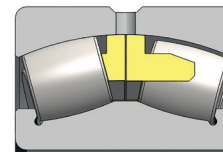

MA design

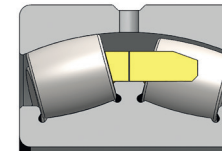

MB design

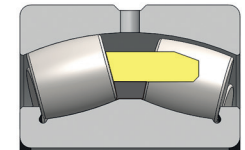

MC design

## Cage materials

Cage constructions from brass or steel, guided on rollers, inner ring or outer ring, in order to accommodate different application conditions.



**Steel cage benefits:** lightweight, high stiffness and impact resilience.  
Nitriding treatment benefits: superior toughness and wear resistance.

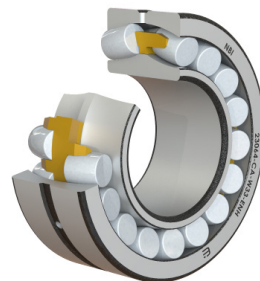

**Brass cage benefits:** better guidance of rollers out of load zone, reduced friction with rollers and improved lubricant flow.

## Lubrication features

Simple lubrication features provided as standard: circumferential groove and lubricating holes in the outer ring.

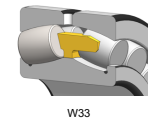

W33

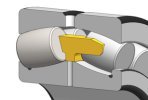

W26

These features are identified with the suffix W33.

For rotating housing/stationary shaft applications, the lubrication holes and groove may be also provided in inner ring, at request.

# SRB Enhanced+ premium line

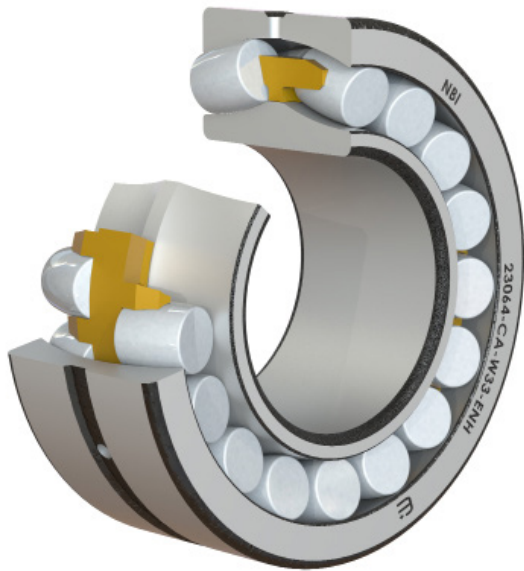

## What is Enhanced+ bearing line?

NBI combines experience in designing and producing bearings with material research and latest technology in manufacturing.

- Premium steel and improved heat treatment
- Tighter manufacturing tolerances
- Enhanced surface finish
- Optimized internal geometry and cage design

## Enhanced+ advantages

- Improved dynamic load rating and consequently longer operating time
- Reduced friction and lower operating temperature
- Downsizing possibility
- Lower overall costs

**SRB**  
(Spherical Roller Bearing)

# SRB series

## NBI Series

213..	240..
222..	241..
223..	239..
232..	238..
231..	248..
230..	249..

## Manufacturing sizes

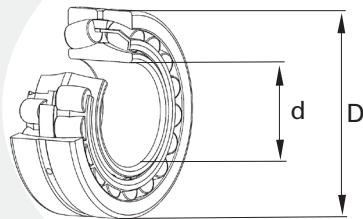

from 25mm  $\varnothing$  inner ring  
to 1.600mm  $\varnothing$  outer ring

## Size variation between series on the same shaft

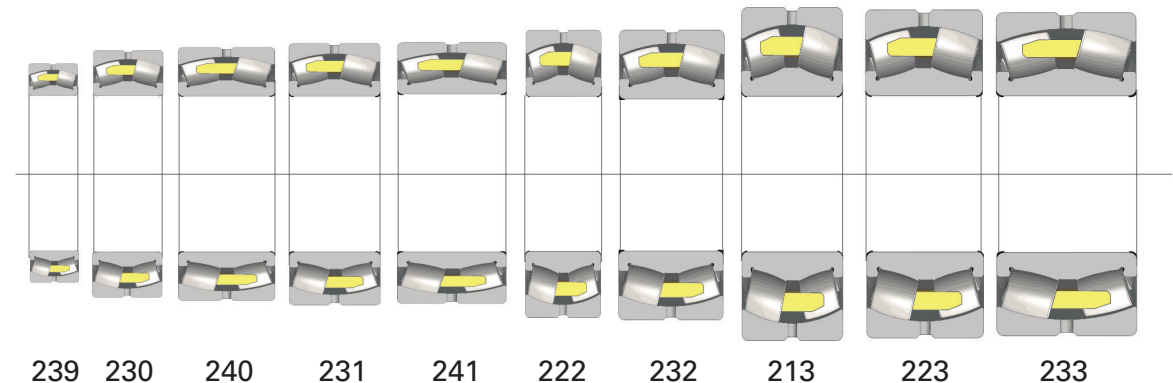

## Examples of NBI customized SRB solutions

### SRB to CE12 specification for vibratory applications

To address the severe working conditions of eccentric shaft support bearings used in vibrating screens, including heavy loads, vibrations, shocks, high rotational speeds and accelerations.

- Available as machined brass and stamped steel cage variant
- Two-piece cage construction
- Both cage types are guided on outer ring for enhanced stability
- Steel cages and guiding rings are nitrocarburized
- Restricted bore tolerance - approx. the upper half of the normal tolerance range
- Restricted OD tolerance - centre half of the normal tolerance range
- Standard C4 clearance (not shown in the bearing symbol)



SRB to CE12 and CE08



Sealed SRB

### Sealed SRB for intensely contaminated environment

To strengthen the bearing protection against contamination under demanding environmental conditions.

- Internal design same as the open bearings
- Contact-type seals on both sides, sheet steel-reinforced, especially developed for spherical roller bearings
- Factory pre-greased

Note: Multiple seal materials are available, however the final selection must be made carefully, considering the operating temperature.

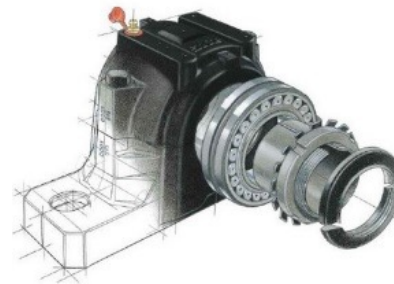

SRB in plummer blocks

### Variety of surface technical coatings for specific application conditions

Some examples:

- **Zinc coating:** to protect from corrosion.
- **Black oxide:** for running-in and under poor lubrication.
- **Hard chromium:** to resist corrosion, wear and friction.
- **PTFE:** for starting up and reducing stick-slip phenomenon.
- **DLC:** for high mechanical strength, reduced wear and optimal friction properties.
- **Nitriding / Nitrocarburizing:** increases the resistance against fatigue, wear and corrosion.

### SRB to CE08 specification for paper applications requiring increased running accuracy

NBI offers spherical roller bearings for paper applications (CE08 suffix), including cylinders, wire/felt rolls.

Particular concerns raised by the paper machines to bearings-bearing being operated under low load regimes, intense water contamination in wet area of the paper machine, high temperatures and thermal shocks which are common in the drying section - are also addressed by specialized solutions:

- Superfinishing of the contact areas for problematic lubrication
- Anti-corrosion coating for bearings in wet section
- P5 running accuracy for inner and outer rings for vibration minimization.

### SRB in plummer blocks

- Heavy-duty bearings enclosed in rugged housings, provided as complete ready-to-mount units that deliver performance in toughest environments
- Factory pre-lubricated with NLGI 2, extended temperature range grease
- Separable housing construction for ease of access
- Choice of seals
- Fixed or floating positions
- Comprehensive dimensional range

## Segments / Applications with typical needs for a premium SRB

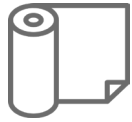

### Paper / Tissue

forming/press rolls, suction rolls, dryer cylinders, Yankee cylinders, wire / felt guide rolls, calender rolls, reel cylinders



### Geardrives / Gearboxes

industrial gearboxes, planetary transmissions, wind turbine gearboxes, slewing drives, marine drives, power splitters



### Minerals processing / Aggregates

jaw crushers, hammer mills, impactors, roller sizers, vibrating screens, apron feeders, conveyor pulleys



### Cement plants

vertical roller mills grinding rolls, geardrives for vertical and horizontal mills, kiln support rollers, clinker crushers, fans and dryers



### Mining / Quarrying / Construction

bucketwheel excavators, drag/hoist/swing machineries for draglines and shovels, trenchers, continuous miners, crushers, tunnel-boring machines, drilling units, conveyor pulleys, compactors



### Energy / Coal-powered plants

coal pulverisers / bowl mills, geardrives, pumps, combustion fans, exhausters, conveyor pulleys, pumps



### Metals

continuous caster rolls, heavy duty reducers and pinion stands for rolling mills, geardrives for auxiliary equipment, coilers/uncoilers, loopers, pinch rolls, runout / transfer / feed tables



### Oil & Gas

mud pumps, drawworks, jackup drives



### Pellet mills / Wood processing

pellet mill rolls, wood cutters, debarkers / chippers, saw mills, chipboard presses, geardrives



### Power transmission - miscellaneous applications

mechanical presses, pumps, compressors, mixers / agitators, textile, elevators / escalators, cranes, wheels, sheaves, winches

# NBI SRB Enhanced + premium performance



## Effects of ENH+ improved features over bearing performance

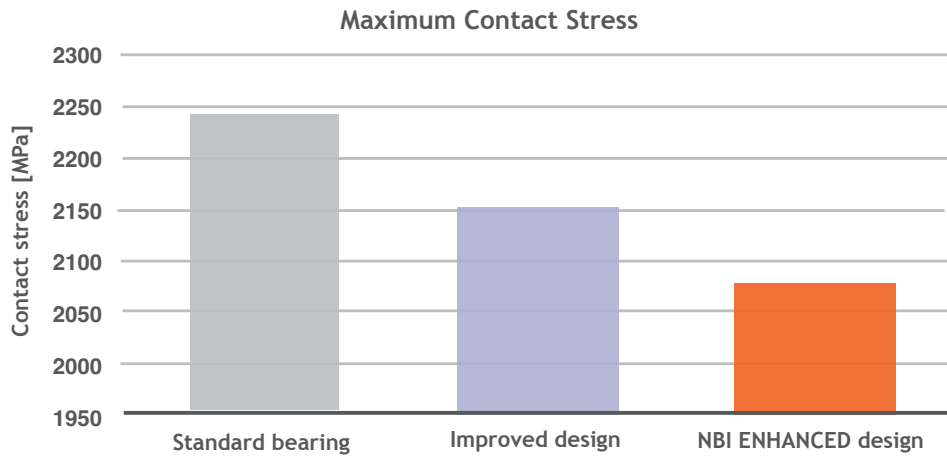

## Highly engineered solutions

Advanced computer simulations using state-of-the-art computer analysis tools, combined with accurate laboratory analysis, confirmed that **NBI E+ Enhanced spherical roller bearings** are fully capable to deliver performance under the most demanding operating conditions.



## SRBs' benchmarking vibration analysis report made in-house

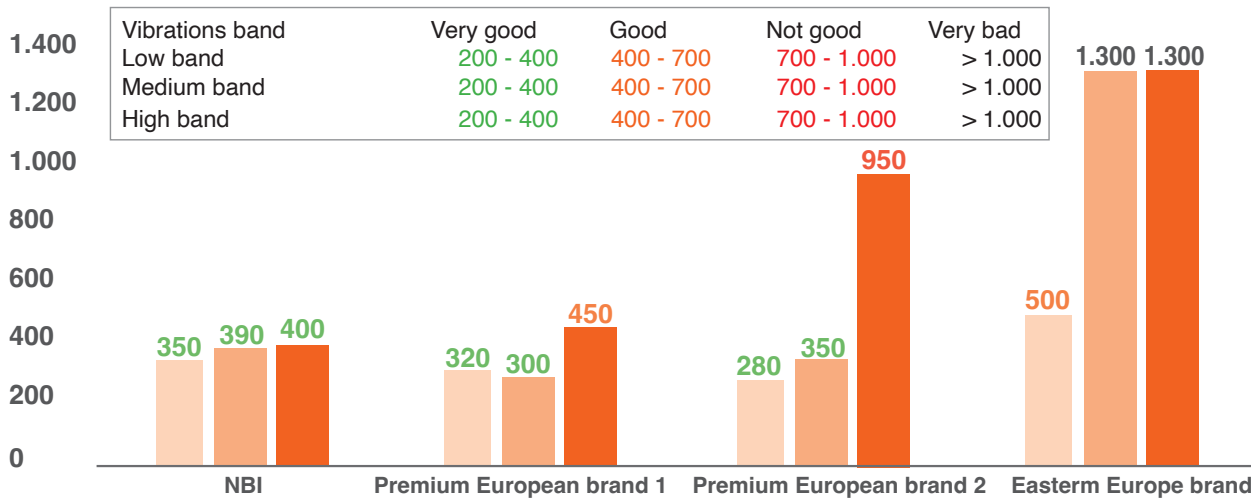

- Low band:
  - Rings (and rollers) roundness. "Macro-geometry" (1:15 filter).
- Medium band:
  - Rings and rollers Wt (undulation). Vibro-finished/super-finished rollers. Cage design.
- High band:
  - Rings and rollers roughness.
  - Cage and rollers contact point geometry and surface finishing. Huge influence of vibro-finished/super-finished rollers.
  - Roller movement freedom between cage and inner ring.
  - Guide ring, outer ring and cage interferences.
  - Guide ring, flatness and ovality error. Cage ovality.

# Part-numbering of NBI SRB

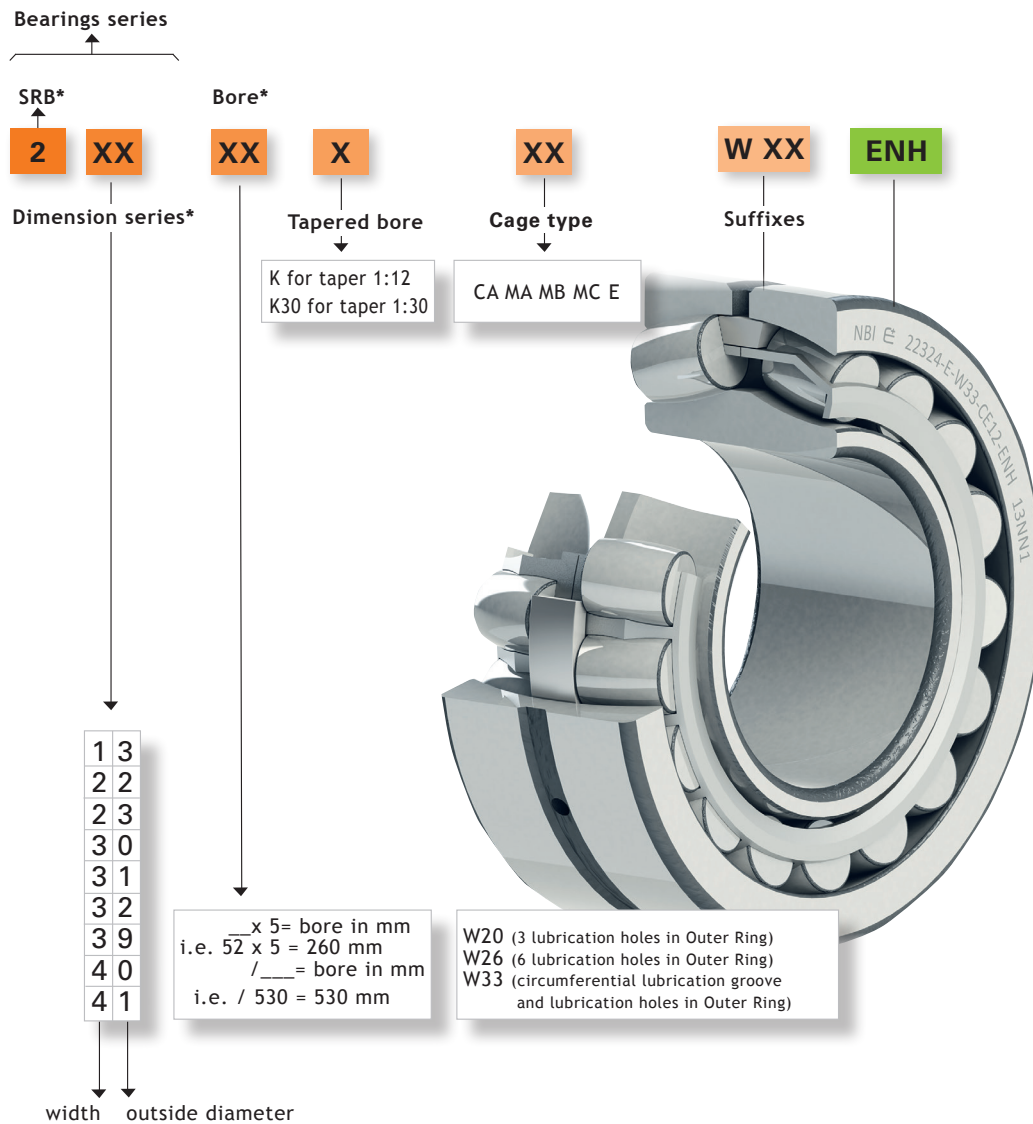

\* Envelope dimensions according to standard ISO 15.  
This includes bore values and series of dimensions.

Suffix	Description
C2	Radial internal clearance smaller than normal
C3	Radial internal clearance larger than normal
C4	Radial internal clearance larger than C3
C5	Radial internal clearance larger than C4
MA	Two pieces solid brass cage, outer ring guided
MB	Two pieces solid brass cage, inner ring guided
MC	Solid brass cage, retaining flanges on the inner ring and guided on rollers.
CA	Solid brass cage, retaining flanges on the inner ring and guide rib guided on the inner ring
CC	Two window-type steel cages, flangeless inner ring and guide ring guided on the inner ring
CE	Two window-type steel cages, flangeless inner ring and guide ring guided on the inner ring with special cage inside diameter
CAF	As CA, but with a steel cage
CAFA	One-piece machined steel cage, double-pronged, guided on the outer ring raceway, retaining flanges on the inner ring and guide ring guided on the inner ring
CAMA	As CAFA, but with a brass cage
E	Two window-type steel cages, flangeless inner ring and guide ring guided on the outer ring
K	Tapered bore, taper 1:12
K30	Tapered bore, taper 1:30
W20	Three lubrication holes in outer ring
W26	Six lubrication holes in inner ring
W33	With a circumferential lubrication groove and lubrication holes in outer ring
L14	Standard grease filling for sealed spherical roller bearing with extreme pressure additives
ORN	Sheet steel reinforced contact seal of acrylonitrile-butadiene rubber on both sides
ORF	Sheet steel reinforced contact seal of fluoro-rubber on both sides
ORH	Sheet steel reinforced contact seal of hydrogenated acrylonitrile-butadiene rubber (HNBR) on both sides on the bearing
CE08	Increased running accuracy to ISO tolerance class 5
CE12	Vibrating screen bearings with reduced inner and outer diameter tolerances and radial internal clearance C4
CE121	Vibrating screen bearings with reduced inner and outer diameter tolerances, radial internal clearance C4 and coated bore surface

NBI can offer, under requirement, alternative designs,  
Should you need a special design, please contact our sales department in NBI Bearings Europe.

# Multi-location NBI manufacturing plants



## Oquendo (Spain)

- Investment up to €10MM
- 2.500 m<sup>2</sup> surface for manufacturing (total area 5.500 m<sup>2</sup>)
- Latest European manufacturing technology to achieve high-precision bearings
- Long term investment plan in place for €10MM to reach 1 meter OD bearing
- Certified with: ISO 9001: 2015



**Current capacity (mm)**  
 Inner diameter 80 ÷ 240  
 Outer diameter 100 ÷ 400

**Incoming capacity (mm)**  
 Inner diameter 240 ÷ 700  
 Outer diameter 400 ÷ 1.000



## Wujin (China)

- Investment up to €18MM
- 15.000 m<sup>2</sup> surface for manufacturing (total area 35.000 m<sup>2</sup>)
- Latest technology to achieve high-precision bearings equipped with an Aichelin thought hardening line and new case carburizing line for multi row roller bearings
- Long term investment plan in place for €4MM
- Certified with: IATF 16949:2016. TÜV, ISO 14001:2015. DNV and ISO 45001:2018. DNV



**Current capacity (mm)**  
 Inner diameter 20 ÷ 1.400  
 Outer diameter 30 ÷ 1.600  
 Specialized in CRB and TRB



## Ahmedabad (India)

- Investment up to €5MM
- 3.000 m<sup>2</sup> surface for manufacturing
- Latest manufacturing technology to achieve high-precision bearings. Automatic lines
- Automatic line for bearing production and heat treatment arriving in 2023. Long term investment plan in place for €9MM
- Certified with: ISO 9001: 2015 TÜV

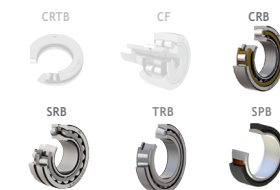

**Current capacity (mm) SRB-TRB**  
 Inner diameter 40 ÷ 125  
 Outer diameter 100 ÷ 200

**Incoming capacity (mm) SRB**  
 Inner diameter 120 ÷ 200  
 Outer diameter < 500

## In-house laboratories equipped with the latest technology



Metrology laboratory



Metallographic laboratory



Other tests laboratory

## NBI Quality

NBI has the latest state-of-the-art heat treatment technology and equipments

 **Quality of raw material** is one of the most critical factors to ensure an enhanced bearing life.

NBI improves rolling contact fatigue life with:

- Enhanced cleanliness. Inclusions size and quantity closely controlled by restricting the chemical composition. Narrower carbides threshold.
- Selection of through hardening steel type according to the rings' and rollers' thickness and improved heat treatment to achieve a better microstructure and hardness uniformity on the functional section.

 **Quality control inspection** procedure throughout the whole bearing manufacturing process



**The most advanced heat treatment**

**Martensitic hardening:** high hardness.

**Bainitic hardening:** strength to resist fracture and absorb shocks

**Case hardening:** can endure heavy shock loads

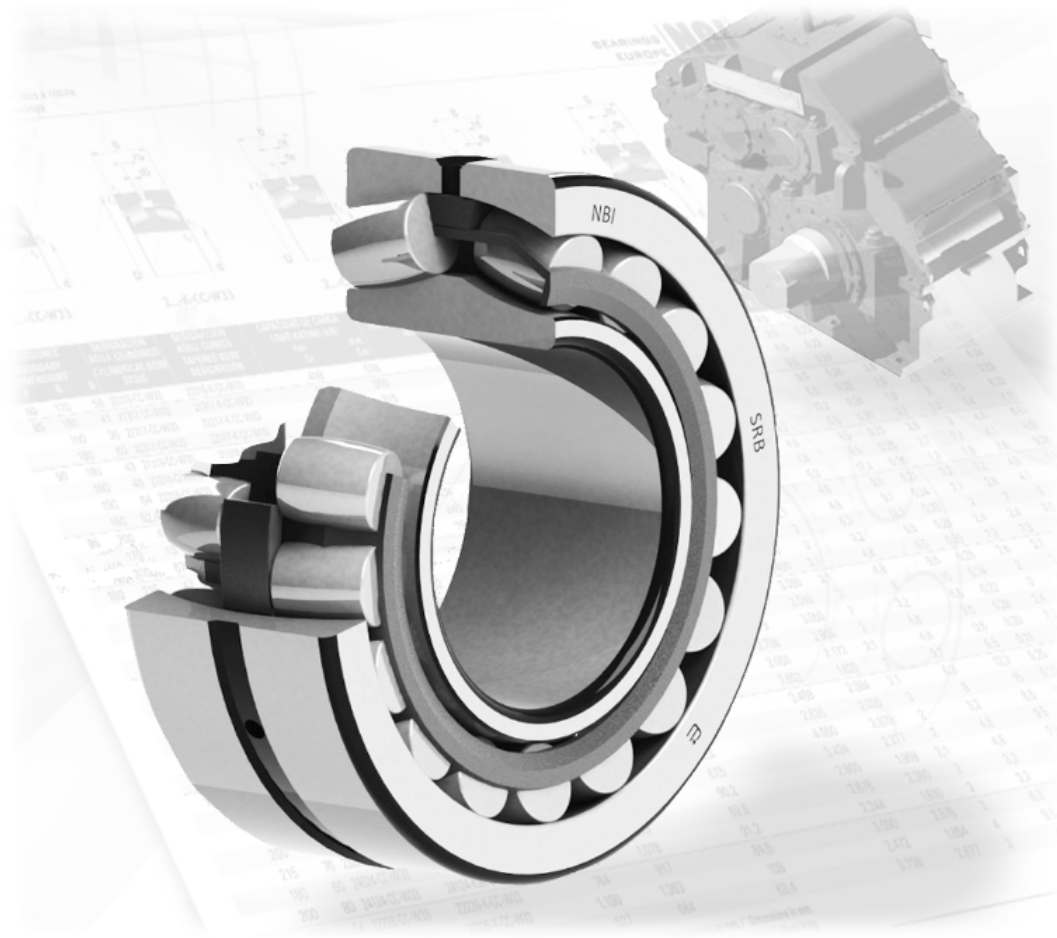

## Spherical Roller Bearings